

INTEGRATED
SECURITY
SYSTEMS

ENG

FOR

FOR

FOR

FOR

FOR

FOR



Our motto: «Creating perfection»

«Creating perfection is a process of steady, incessant movement forward, a constant desire to create the impossible. When created, you realize that perfection is still ahead».

— **Yuriy Stoyanov**
Chairman of the Board of Directors, STILSOFT

A handwritten signature in black ink, consisting of stylized initials 'YS' enclosed within an oval shape.

STILSOFT

STILSOFT is a leading developer and manufacturer of integrated security systems, special equipment, unmanned aerial vehicles and space systems.

**RESEARCH
AND DEVELOPMENT**

INNOVATIONS

**HIGH-TECH
PRODUCTION**

**EQUIPMENT
CERTIFICATION**

**SPECIALIZED
TRAININGS**



STILSOFT

OUR ADVANTAGES



**RUSSIAN DEVELOPER
OF SECURITY EQUIPMENT
AND SPECIAL SECURITY
SOLUTIONS**



**FULL-CYCLE
PRODUCTION**



YEARS

OF SUCCESS

**PROJECT
PROTECTION**

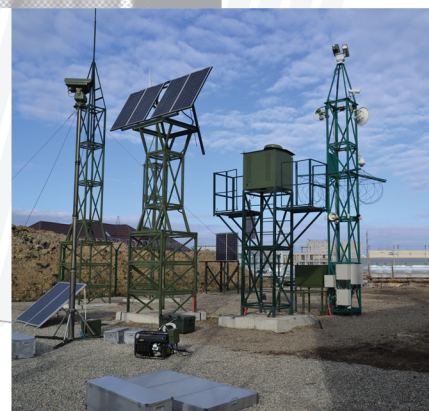

**EXPERIENCE IN EXPORT
DELIVERIES TO NEAR
AND FAR ABROAD
COUNTRIES**



**USER-FRIENDLY
ENGINEERING SOLUTIONS**

**MILITARY
ACCEPTANCE**

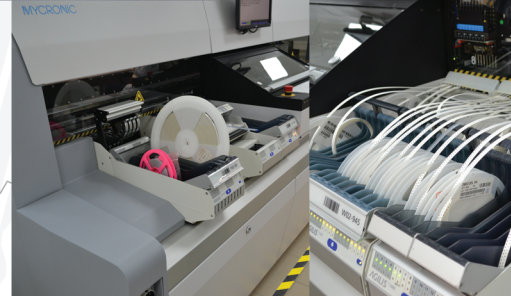

**INDIVIDUAL
APPROACH**

**REFINEMENT ACCORDING
TO THE CUSTOMER'S REQUIREMENTS**



STILSOFT

TESTING LABORATORY



The laboratory conducts certification tests of technical means to ensure equipment's compliance with the requirements of the Government Decree of the Russian Federation No. 969 and Federal Law No. 16-FZ «On Transport Security».

STILSOFT testing laboratory provides services throughout the territory of the Russian Federation. We also hold field certification tests of security products at the applicant's transport infrastructure facilities.

^ CERTIFIED

VERIFICATION LABORATORY

The laboratory provides metrological verification for a big number of systems for photo and video recording of traffic violations.

The advantage of STILSOFT laboratory is a «turnkey» verification of photo and video recording systems of traffic violations directly at the system installation place.

^ CERTIFIED

STILSOFT

PRODUCTS AND SOLUTIONS



INTEGRATED SECURITY SYSTEMS



**SYSTEMS WITH
UNMANNED AERIAL VEHICLES**



**SPECIAL SOLUTIONS
FOR FEDERAL FORCES**

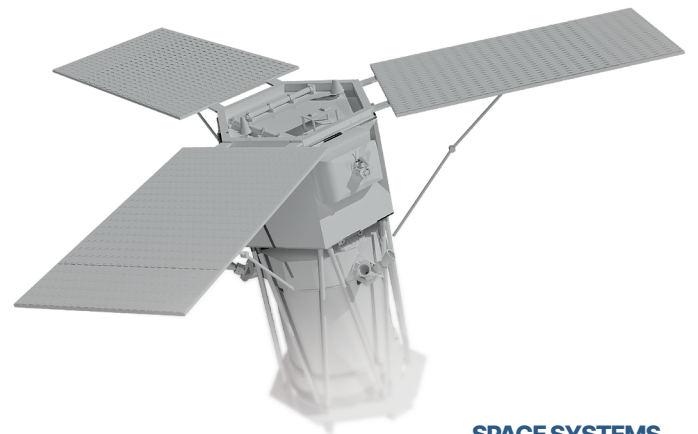

SPACE SYSTEMS

STILSOFT

INTEGRATED SECURITY SYSTEM «SYNERGET»



designed to organize the protection
and defense of the facility, response force control

SYNERGET

«Synerget» Integrated security system (ISS) is a hardware and software system with artificial intelligence elements. «Synerget» includes multiple elements with each of them being a functional and finished product. All the components can operate separately or – by combining with other parts into a single «Synerget» ecosystem – organize a system for ensuring security at facilities of any scale and complexity

SYSTEM STRUCTURE:

- | | | |
|----|--|--|
| 01 | video surveillance system (VSS) | includes a series of video cameras and video servers of our own production, supports contemporary integration protocols for third-party cameras, enables display and recording of video channels, has a built-in system of video analytics |
| 02 | access control and management system (ACMS) | includes a series of network controllers and a set of terminal equipment, enables implementing complex entry algorithms. The system uses original algorithms for identifying license plates, face recognition and controlling body temperature. It is certified for handling personal data |
| 03 | perimeter protection system (PPS) | includes a data transmission and power management system based on universal controllers and security sensors with various physical operating principles of our own production |
| 04 | intrusion alarm system (IAS) | consists of network-based receipt and control devices and security detectors. Devices are highly reliable and have a stylish industrial design |



05	fire alarm system (FAS)	detects early signs of the fire or smoke appearance at the protected area, timely informs the staff about the fire and the need to evacuate, as well as instructs on the evacuation ways and order includes addressable and analogue-addressable receipt and control devices and fire sensors. «Synerget» also supports integration with third-party FAS
06	public address system (PAS)	includes a series of network transmission amplifiers and loudspeakers with an Ethernet interface and standard PoE power supply
07	data collection and processing system (DCPS)	has a user-friendly interface and extensive application of artificial intelligence. DCPS includes decision support and multiple analytical subsystems

«Synerget» integrated security system widely applies an Ethernet technology and the Industrial Internet of Things concept enabling implementing decentralized distributed systems in the modular design principle. This approach multiplies the system reliability, minimizes the human factor impact throughout the design and equipment stages and also simplifies the facility operation.

«Synerget» ISS is the special software adapted to work with different operating systems, protected and certified for handling classified information.

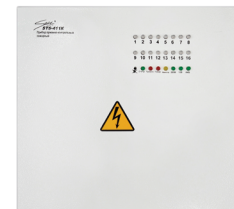
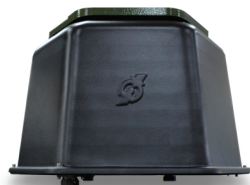

Specialized products based on SYNERGET ISS:



«SYNERGET VK» integrated security system
is for the highest protection category facilities of the Ministry of Defense of the Russian Federation

«ACCEPTED FOR SUPPLY OF MINISTRY OF DEFENSE OF RUSSIAN FEDERATION»



«SYNERGET 1 SV» integrated security system
is for I, II and III protection category facilities of the Ministry of Defense of the Russian Federation

«ACCEPTED FOR SUPPLY OF MINISTRY OF DEFENSE OF RUSSIAN FEDERATION»



«SYNERGET SETMSP» integrated security system
is for facilities of the Border Control Service by Federal Security Service of Russia

«RECOMMENDED FOR USE BY FEDERAL SECURITY SERVICE OF RUSSIA»



All SYNERGET devices are intelligent and interact with each other.

MODEL ISS SYSTEM

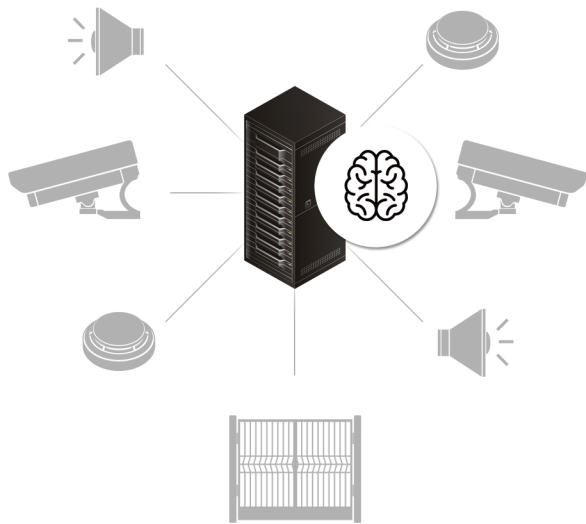

SYNERGET ISS SYSTEM

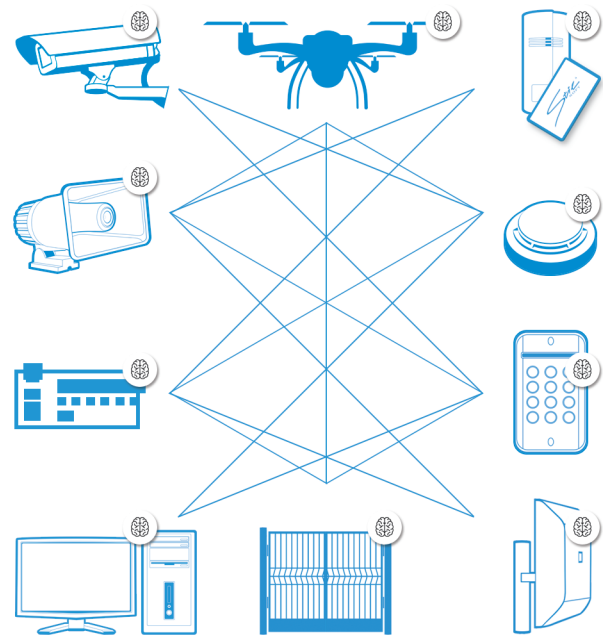

CROSSPLATFORM SUPPORT



PLATFORMS



TECHNOLOGIES FOR ALL DEVICES

ETHERNET

PLUG & PLAY

PoE

NUMBER OF DEVICES IN THE SYSTEM

400+

Own production

4000+

Third party production

DECENTRALIZED
STRUCTURE

DISTRIBUTED
MULTI-LEVEL CONTROL
SYSTEM

ARTIFICIAL
INTELLIGENCE

PROTECTED
CERTIFIED PROCESSING
OF INFORMATION

OPERATOR DECISION
MAKING SUPPORT

SYSTEM CURRENT
STATE MONITORING
AND FUTURE ANALYSIS

STILSOFT

SPECIAL SOLUTIONS FOR FEDERAL FORCES

SPECIAL SOLUTIONS FOR FEDERAL FORCES



«AVANPOST»

AUTONOMOUS VIDEO AND
THERMAL IMAGING SYSTEM

ACCEPTED FOR SUPPLY
OF BORDER CONTROL SERVICE
BY FEDERAL SECURITY SERVICE
OF RUSSIA

ACCEPTED FOR SUPPLY
OF MINISTRY OF DEFENSE
OF RUSSIAN FEDERATION

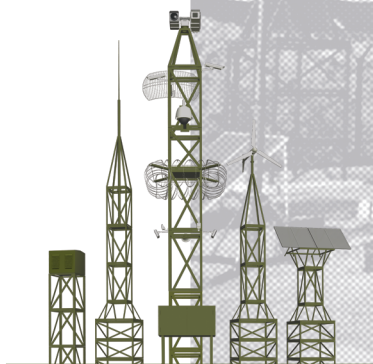

Provides security and intellectual video surveillance
of large open spaces and state borders

System provides 24/7 visual control to detect various types of targets at the distance up to 10 km. The main element of the system is an optical-electronic module: a long-range video camera and thermal imaging camera. The system transfers real time video information to the operator's workplace, located remotely from the linear observation post.

Features: autonomous power supply using wind and solar energy, target detection in all weather conditions using radar; easy operation, high reliability.



«MUROM»

FAST-DEPLOYMENT AUTONOMOUS
MOBILE VIDEO SURVEILLANCE
AND THERMAL IMAGING SYSTEM

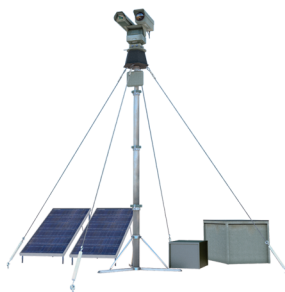

The system is designed for fast deployment of 24/7 long-range video and thermal imaging surveillance post at large open spaces

System provides 24/7 visual control to detect various types of targets at the distance up to 10 km. The system includes a pneumatic mast, an optical-electronic module with a long-range video camera and thermal imager; autonomous power supply system based on solar modules and a gasoline generator. System allows operators to see real time video on a rugged notebook or at the operator's automated workstation located remotely from the system installation place (automated operator's workstation is not included into the delivery package, can be supplied separately). System deployment time is less than 1 hour.

Specialized products based on the MUROM system:

ACCEPTED FOR SUPPLY
OF MINISTRY OF DEFENSE
OF RUSSIAN FEDERATION

ACCEPTED FOR SUPPLY
OF BORDER CONTROL SERVICE
BY FEDERAL SECURITY SERVICE
OF RUSSIA

«MUROM 1 SV» - designed to protect temporary locations of moving military units outside of their permanent locations

«MUROM-P» - designed for State Border protection tasks





«BARRIER»

ARMORY VAULT
DOOR SECURITY SET

ACCEPTED FOR SUPPLY
OF MINISTRY OF DEFENSE
OF RUSSIAN FEDERATION



Is intended for arranging security measures in weapon storage room and restricted access rooms.

A metal door with embedded equipment: two video cameras, process controller and a set of wireless security sensors (volumetric, surface and sound ones). The set provides physical barrier to entry, detecting intrusion signs in secured facility and video recording. The set also implements collecting, processing, transmitting and providing information, SMS reporting, voice announcement on tampering, alarm and emerging malfunctions.



«SCORPIO»

OFF-ROAD VEHICLE BASED
VIDEO SURVEILLANCE AND
THERMAL IMAGING SYSTEM

ACCEPTED FOR SUPPLY
OF BORDER CONTROL SERVICE
BY FEDERAL SECURITY SERVICE
OF RUSSIA



Off-road vehicle based system for fast deployment of 24/7 long-range video and thermal imaging surveillance post at large open spaces.

The system includes: pneumatic mast (4.2m height), optical-electronic module with a long-range video camera and thermal imager installed in the cargo compartment of the car. Provides 24/7 visual control to detect various types of targets at the distance up to 10 km. The operator's workplace is located in the passenger part of the car. The car is equipped with a night driving set, autonomous interior heater and air conditioning. Radar is used to detect targets in difficult weather conditions.



«ENERGET 1 CMBA»

BACKUP POWER
SUPPLY SYSTEM

ACCEPTED FOR SUPPLY
OF MINISTRY OF DEFENSE
OF RUSSIAN FEDERATION



Is intended for arranging backup power supply in security sites

Structurally, ENERGET 1 CMBA is a metal container with a 30 kW diesel generator located inside and an uninterruptible power supply of the same power. The container is equipped with a heating and ventilation system that allows to work efficiently in a wide temperature range.

Embedded security subsystem provides access control, fire protection and prevents unauthorized fuel use. ENERGET 1 CMBA supports automatic switching of power supply between consumers without interrupting their power supply.



«HIVE 1 M»

MOBILE ACCESS
CONTROL SET

ACCEPTED FOR SUPPLY
OF MINISTRY OF DEFENSE
OF RUSSIAN FEDERATION



Designed for fast-deployment organization of temporary access control checkpoints

The set consists of a mobile control point – a rugged notebook laptop, smartphone based mobile readers and a set of proximity cards. The mobile control point works as a checkpoint office. The mobile reader allows to identify visitors using proximity cards and biometric face verification. The mobile reader can be operated from the control center (via wireless communication channels) and also can work independently.



«SKYRON O»

UAV BASED ADJACENT TERRITORY CONTROL SYSTEM



Provides operational monitoring and video shooting of protected areas; violators detection, missing people search in emergency places

The system includes UAV equipped with a removable payload and a ground control station. UAV provides video and thermal imaging surveillance. UAV flight control, flight tasks configuration, viewing and recording the data received in a real time mode - are carried out from the ground control station.

Features: possibility of fully automated flight task performance, as well as reliable functioning in difficult weather conditions.



«SKYRON SO»

UAV BASED ADJACENT TERRITORY MONITORING SYSTEM



Provides operational monitoring and video recording of protected areas; facility perimeter patrolling, visualization of alarm signals received from security sensors or radars used in the perimeter protection system.

System includes: start container, UAV and automated operator's workstation, which can be located remotely. The start container is used for UAV basing, take-off, landing, charging UAV's battery, weather conditions monitoring and organizing communication between UAV and operator. Take-off and landing to the container are possible both in fully automated or manual mode. The range of the system is 5 km. UAV can be equipped with a video camera or a thermal imager.

Features: reliable functioning in difficult weather conditions, as well as effective counteraction to electronic warfare means.

STILSOFT

SPACE SYSTEMS

EARTH REMOTE SENSING



«STILSAT-1»

EARTH REMOTE
SENSING SATELLITE

The satellite is designed to obtain high resolution images
of Earth's surface

Sensor spatial resolution

0,5 m

Orbit altitude

520 km

Mass

420 kg

Swath

12 km

SPACE SYSTEMS

STILSOFT

UNITING THE IMPOSSIBLE –

«SYNERGET: Situation management» analytical system is designed for security forces and safety equipment management



CREATING THE UNRIVALED

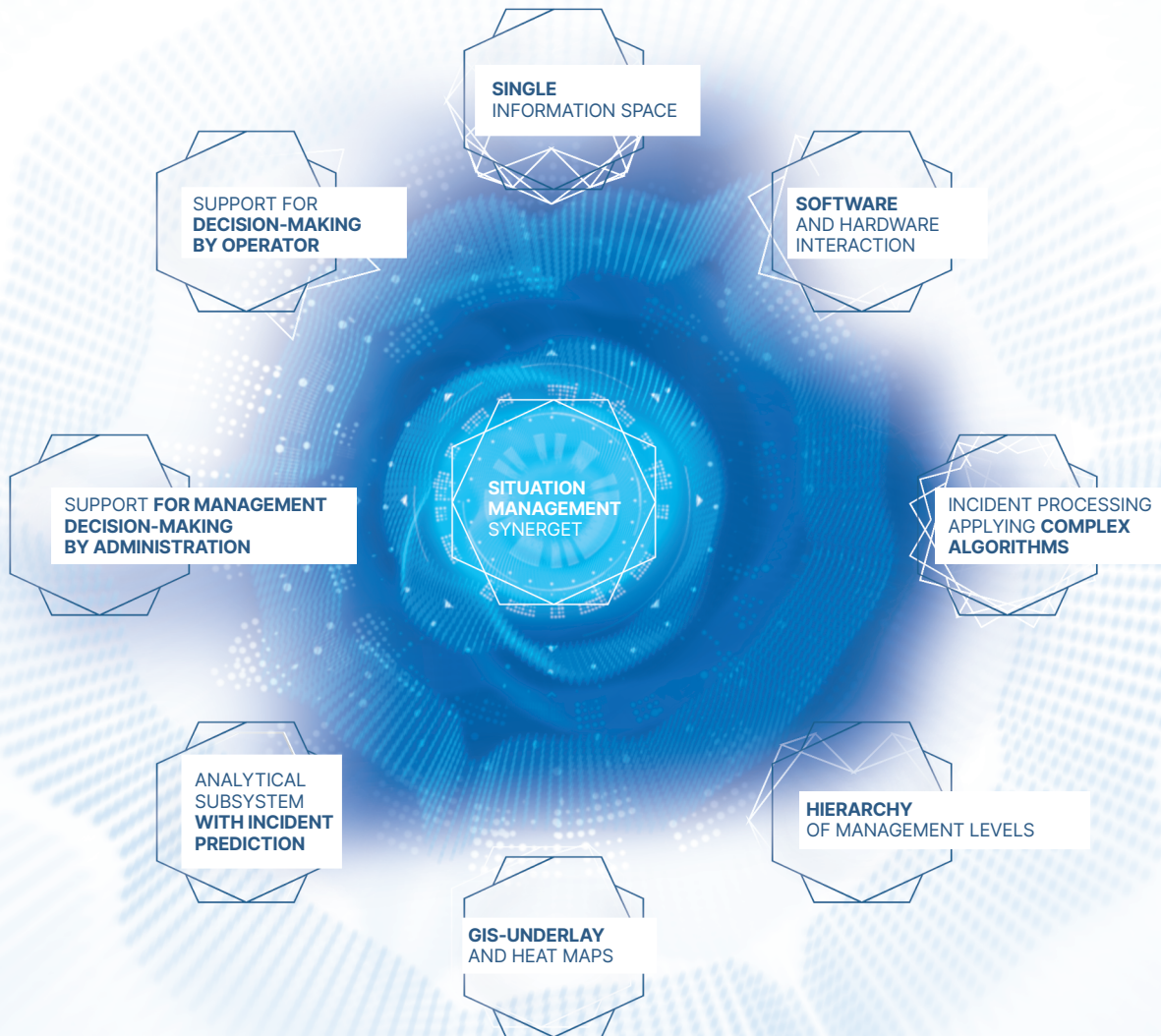

STILSOFT

WE HAVE MUCH TO BE PROUD OF

We produce

600 000

units per year

Over

50

new products developed annually

Export

to **20**

countries worldwide

Over

50 km

length of a facility perimeter



the most northern facility in the world



the largest detention facility in Europe



the most southern facility in the world



the highest mountain video surveillance system in Europe

Over

400

items passed state trials and accepted
for supply in security agencies

Over

10 000

facilities equipped with
STILSOFT hardware

Over

700

products of our own production



From Franz Josef Land
to Antarctica

STILSOFT

INNOVATION TECHNOLOGICAL EFFICIENCY RELIABILITY

Over 1500 highly qualified specialists in the company conduct development and production activities for a wide range of equipment, software and integrated security systems.

STILSOFT activity in implementing major projects honored with commendations from leaders of the federal agencies and structures. The latest developments of the company are regularly presented to the highest leadership of the country.





The Chairman of the Board of
Directors of STILSOFT
**presents the latest
developments to
the country's leadership**

STILSOFT

CONTACTS

STILSOFT pays special attention to its customers by organizing the work so that no call or request remains unanswered. Our specialists are always ready to provide any kind of information according to customers' interests.

Headquarters:

355042, Russia, Stavropol City, Vasilkovaya st., 29

Telephone: +7 (8652) 52-44-44, +7 (495) 663-71-75

Fax: +7 (8652) 52-88-88

Email: info@stilsoft.ru

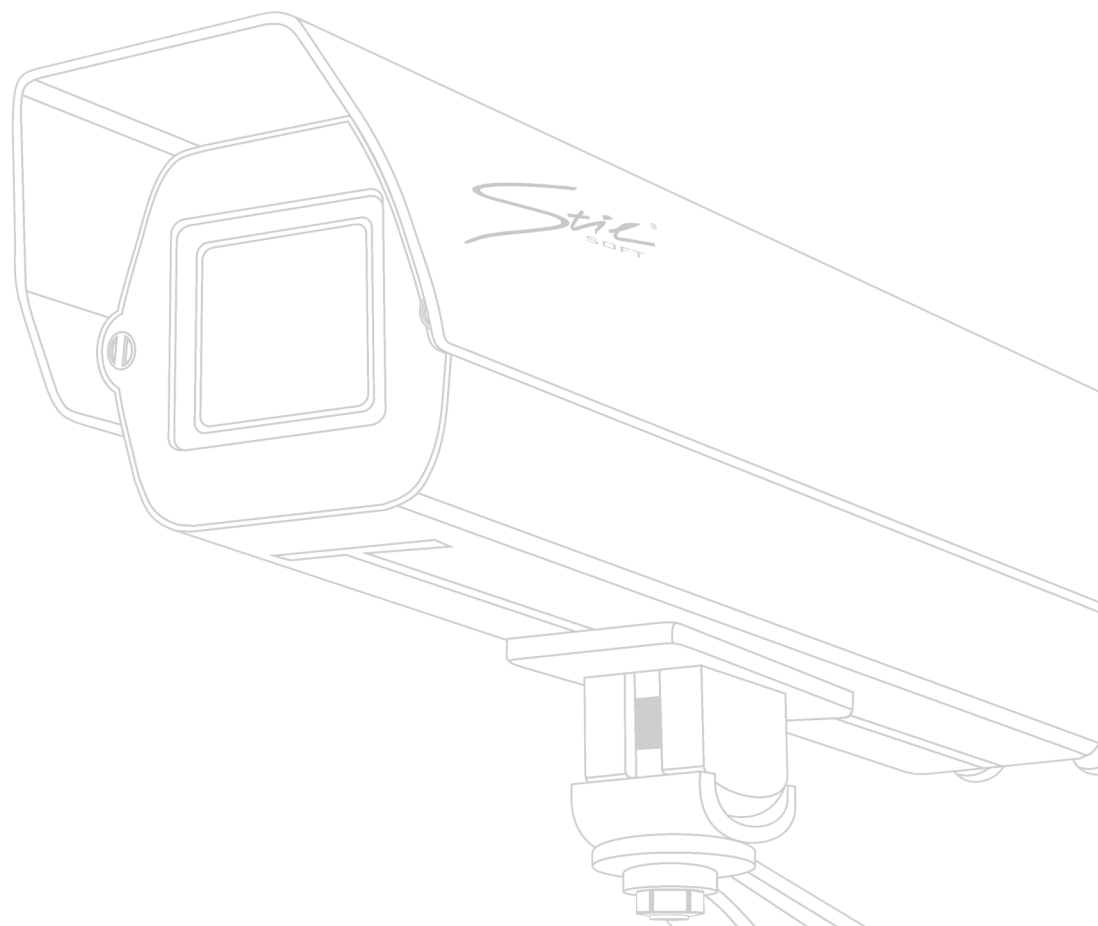

STILSOFT. SU

